



Iconic
PVCu Sliding Sash Windows



Traditional Characteristics

Windows are so much more today than simply a way to illuminate the inside of your home. Our iconic sliding sash windows, give you the opportunity to introduce wonderful character and identity to your home while keeping you safe and warm.

The traditional sash window was purportedly invented by Robert Hooke (of Hooke's law fame) around 1670 and is a wonderful reflection of Victorian and Georgian English properties with their elegant curves and robust design.

In a modern twist we have sympathetically re-engineered the window in a robust low maintenance PVCu with a myriad of decorative options including sash horns, glazing bars and a deep bottom rail to replicate the style of yesteryear.



Contents

Thermal Efficiency.....	Page 3
Security.....	Page 3-4
Features.....	Page 5
Hardware.....	Page 8
Colour Options.....	Page 9
Obscure Glass.....	Page 9
Styles & Shapes.....	Page 12
Technical Information.....	Page 13

Superb Thermal Efficiency

Today's window designers have far more challenges than previous generations. Not only do they need to design windows to withstand the elements, but they have to consider the environmental impact too.

Up to 'A+' Energy Rated

Our sash windows include brush seals around the openings for exceptional draught proofing and to assist the environment. 'Low E' glass together with a warm edge spacer bar provide exceptional heat retention, and a superior 'A+' energy rating where required.

Recyclable PVCu

Selecting PVCu is an environmentally friendly choice, as the majority of end of life PVCu windows will be recycled.

By choosing our sliding sash windows you are not only keeping your home warm all year round and reducing your heating bills, you're also helping the environment.

Fire Escape

If your window opening isn't large enough, you have the option to request an egress fire escape facility. We always recommend checking the current compliance with one of our product experts.

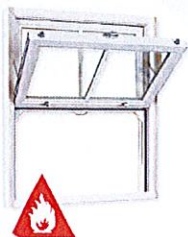

Peace of Mind

Our **iconic** sliding sash windows have been designed with not only elegance and authenticity in mind, but security too. The sliding sash windows are multi-chambered and reinforced to prevent deflection through differing climates. This reinforcing also acts as secure fixing points for handles, latches and other screw fixed components. The balances maintain the equilibrium of the sash window at all points of travel and robust locking devices enhance the security of your home.

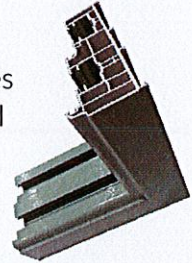

PAS 24:2016 Upgrade

Upgrade the security of your sliding sash windows by taking advantage of our PAS 24:2016 security package. This enhancement includes the following four upgrades. This is generally mandatory on new-build projects.



**Reinforced
Tilt Latches**

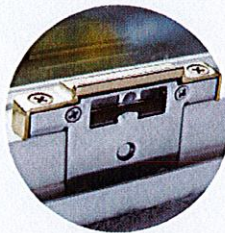

**Upgraded
Locking Keep**

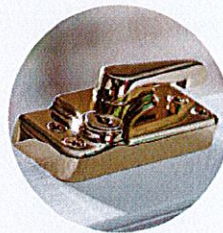

**Upgraded
Lock x2**



**Top Sash
Security Blocks**

Secured by Design Upgrade

If you would like to take the security of your sliding sash windows a step further you can also opt for the 'Secured by Design' package, which incorporates all of the enhancements from the PAS 24:2016 but with the additional inclusion of 6.8mm acoustic laminated glass supplied by Pilkington.



Please note that the Fire Escape, 'Secured By Design' and 'PAS 24:2016' upgrades are not standard and must be requested as part of the window specification.

Iconic Features

Our **iconic** sliding sash windows are manufactured using PVCu profiles designed to truly emulate traditional heritage frames. From a terraced house to a stately home, our vertical sliding sash windows ensure that your property retains its character and charm. You can choose from a wide range of styles, features and hardware options to complement your home.



Slide and tilt facility

As standard, our sliding sash window comes with a slide and tilt facility*, allowing you to clean both the top and bottom sash from inside your home.

Seamless Corner Welds

We are proud to offer a seamless welded sash window. This revolutionary process now disguises the external 45-degree corner welds with a flush mitre providing a far superior aesthetic finish. Available on woodgrain windows only and a minimum window size of 475mm wide x 900mm high.

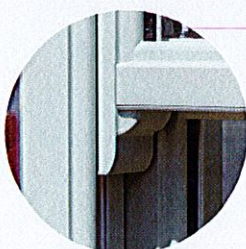

Run-through

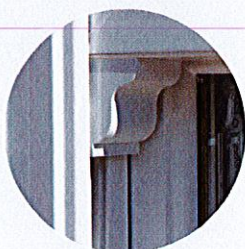

Plant-on

Iconic Sash Horns

Enhance your window by choosing either run-through or plant-on sash horns. The run-through utilises mechanical joints rather than welded to allow the horn to be a continuous part of the sash giving the window a more authentic overall look. The plant-on is a sculptured moulding that is fixed to the underside of the top sash.

Deep Bottom Rail

Choose a deep bottom rail if you want your sliding sash windows to look as close to the original timber version as possible. The larger bottom rail sash convincingly mimics the timber sash windows of old. The deep bottom rail is available with welded or mechanical joints.



Trickle Vents

Although, a well-insulated home is important, a well-ventilated home is equally as important. Trickle vents provide background ventilation and are generally mandatory under Building Regulations. An internal flap enables the vent to be opened and closed as required.

*Please note that on windows with a woodgrain finish external and smooth finish internal we are not able to offer top sash tilt facility.

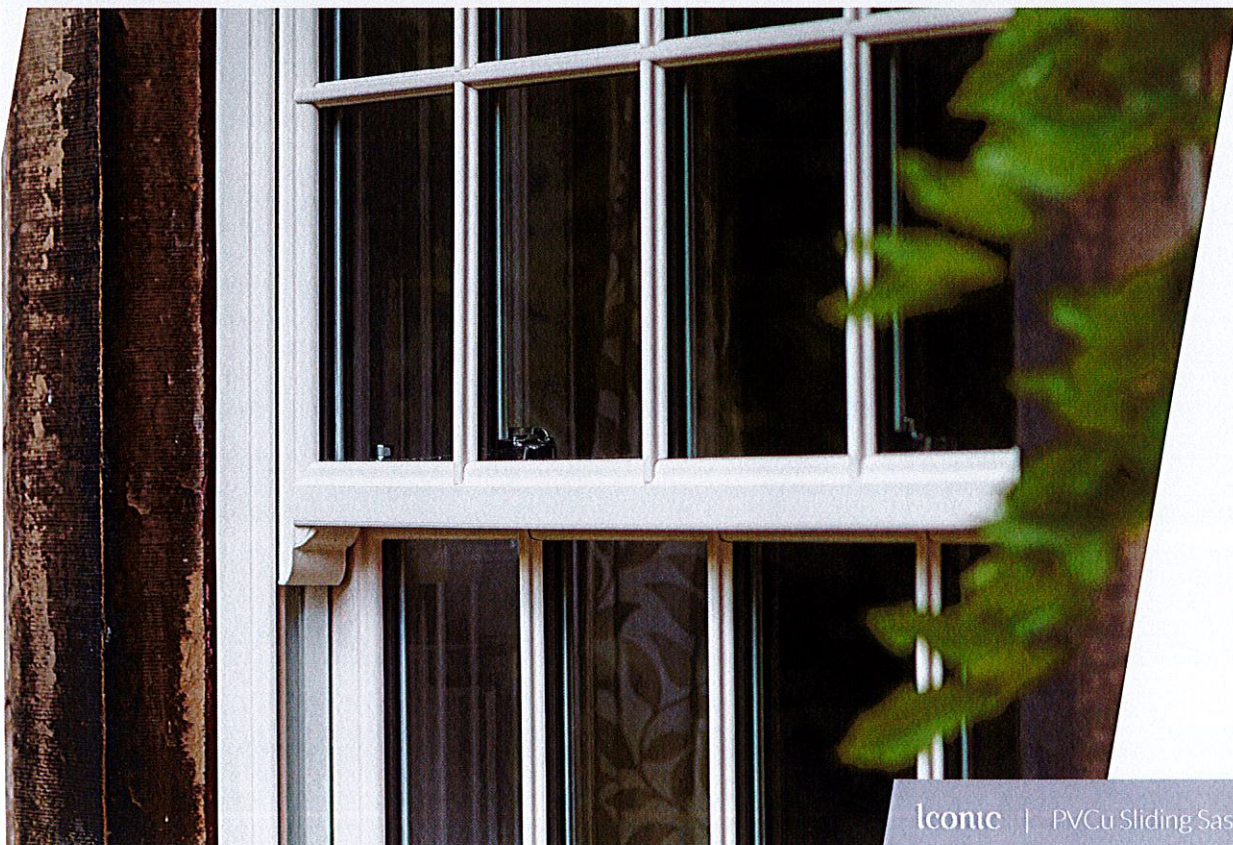



Iconic Hardware

Travel Restrictors

The travel restrictors limit the opening of the top and bottom sashes to approximately 100mm. They are primarily used as a safety feature in locations where opening restrictions are needed. The magnetic mechanism can be overridden from inside your home allowing for a larger opening.



Sash Pull



All our PVCu Sliding Sash Windows come with one or two sash pulls as standard depending on window size. The sash pulls are usually fitted on the inside of the bottom sash to allow easy opening.

D Handle

Designed to be fitted to the underside of the top sash on the outside of the window to assist with the opening and closing of the window. Alternatively, you can request the D handle to be fitted to the inside top sash.



Pole Eye



Primarily designed to be fitted to the top rail of the top sash. The pole eye enables use of a pole with hook (not supplied) to operate any windows that are positioned too high to operate by hand.

Locking System

Our locking system holds the sash window shut by fastening the mid-rails together. The locking system is available in two styles.



Standard Lock

Heritage Lock

Sash Knob

Used to open and tilt the sashes for easy cleaning of the outside frame and glass from inside your home.



Standard Knob

Heritage Knob

Hardware Colours

Our hardware is available in eight different finishes. Please note that our travel restrictors are only available in white, chrome, gold and satin chrome.



White



Black



Chrome



Gold



Satin Chrome



Graphite



Bronze



Antique Black

Colour Options

With our **iconic** sash windows you can choose a colour that suits your property perfectly and that gives it that first impression you've always dreamt of. As standard our sash windows come in a smooth white finish, although because every home is different we offer a large range of different colours in both a smooth and woodgrain finish.

Woodgrain Colours

Our **iconic** sliding sash windows are available in eight standard woodgrain colours. By choosing a woodgrain foiled finish you are able to bring your windows to life with a glossy, freshly painted, realistic timber effect.



Bespoke Colour-bonding

If you're looking to add a true personalised touch to your new windows, we offer a bespoke colour bonding service in which you can choose between more than 1000 colours in either a smooth or woodgrain finish. Some of our most popular RAL colours are shown below. Please note that lighter / darker shades are available and we're always happy to help you find the perfect colour to suit your home. Just ask!

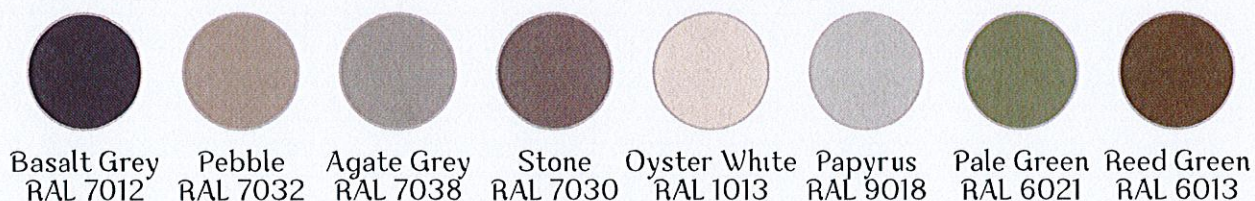

Obscure Glass

Obscure glass is typically utilised in bathrooms, shower rooms and other private areas. Our sliding sash windows can be specified with a variety of different glass patterns and obscurity levels to suit your needs.







Styles and Shapes

Our **lcontic** sliding sash windows can be manufactured to a style to suit your home. Below are a few examples of the different bar layouts available. Our windows come with equal sized top and bottom sashes (50/50 split) as standard, however we are able to manufacture other split ratios at your request (minimum transom drop of 350mm). Please get in touch if you require a bespoke style or bar layout.

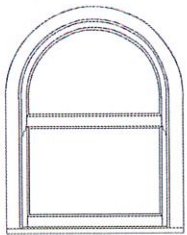
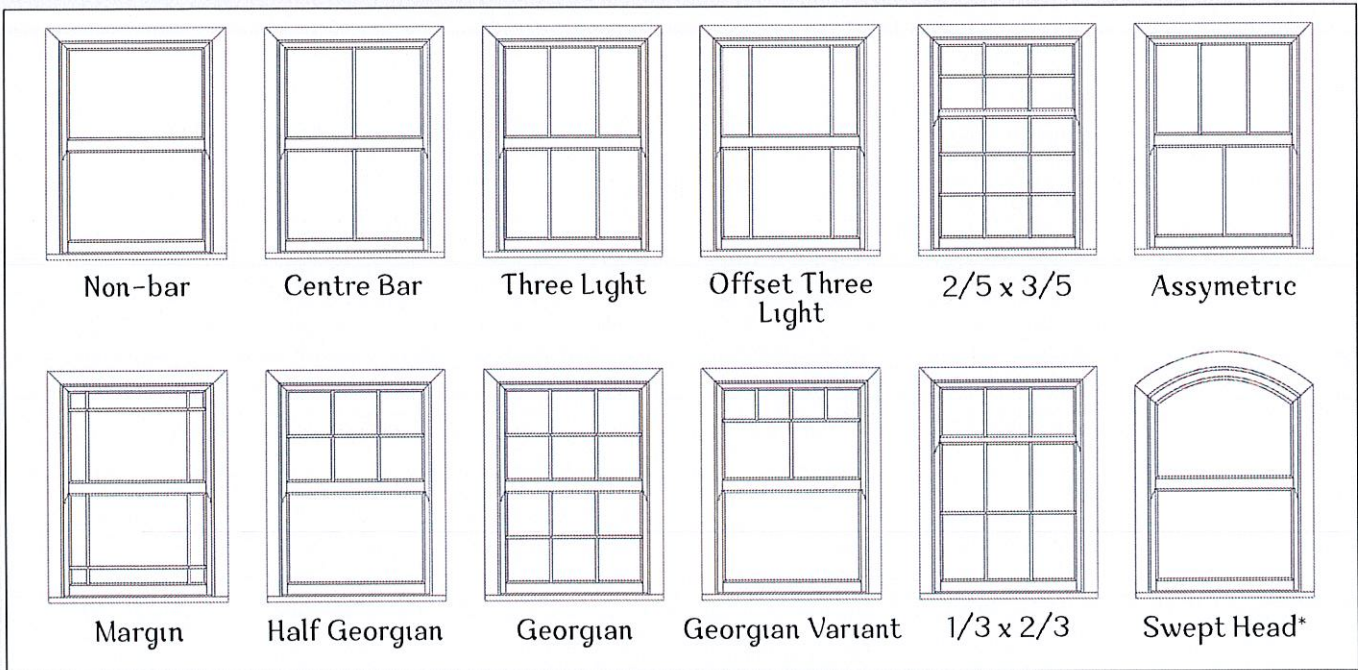

True Arch*

Seamless True Arch

PVCu sliding sash windows are notoriously difficult to work with when it comes to bending profiles and we're therefore very proud to be able to offer the only true arched PVCu sash window in the country with no welded joints in the frame.

Coupled and Bay Windows

Coupled- and bay windows are both very popular for large openings as they open up the living space and bring in natural light.

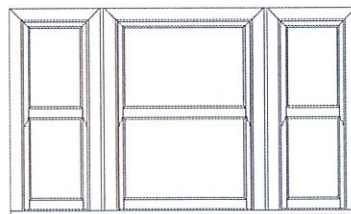

Coupled Windows

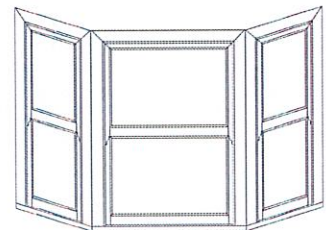

Bay Windows

*Please note that on swept heads and arched frames the top sash will always be fixed.

Technical Information

Our technical information section covers manufacturing limitations and detailed technical drawings. To most people the technical drawings don't make much sense, so if you have any questions our product experts will be more than happy to explain in more detail.

Technical Specifications

Front to back dimensions: 135mm
 Glazing units: 24mm double glazed
 U-value: 1.4W/m²K - 1.5W/m²K

Manufacturing Limitations*

Minimum width: 360mm
 Maximum width: 1500mm
 Minimum height: 750mm
 Maximum height: 2350mm

Technical Drawings

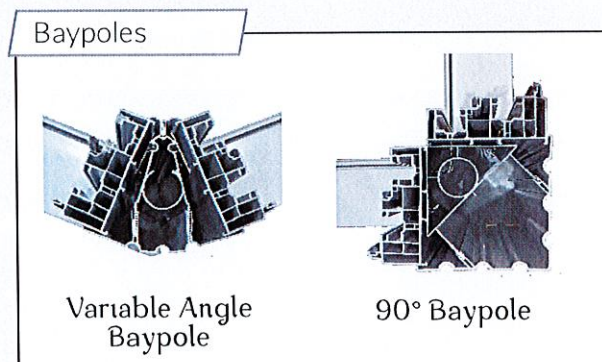
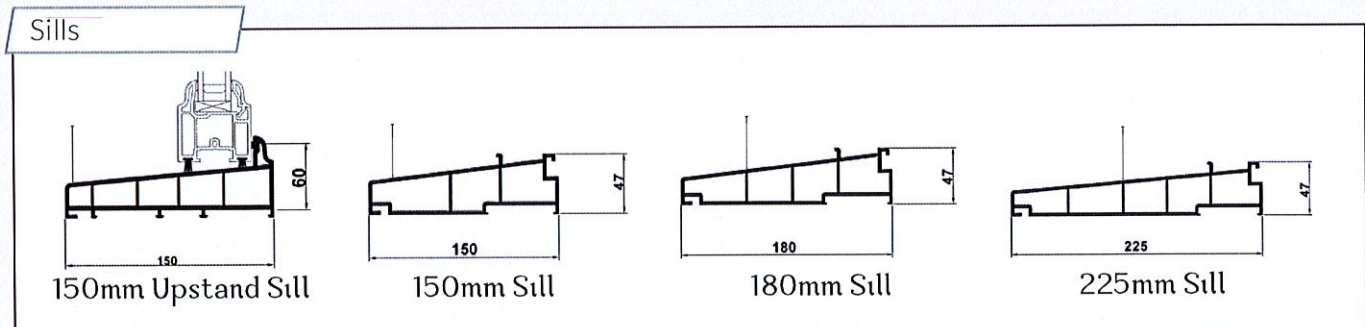
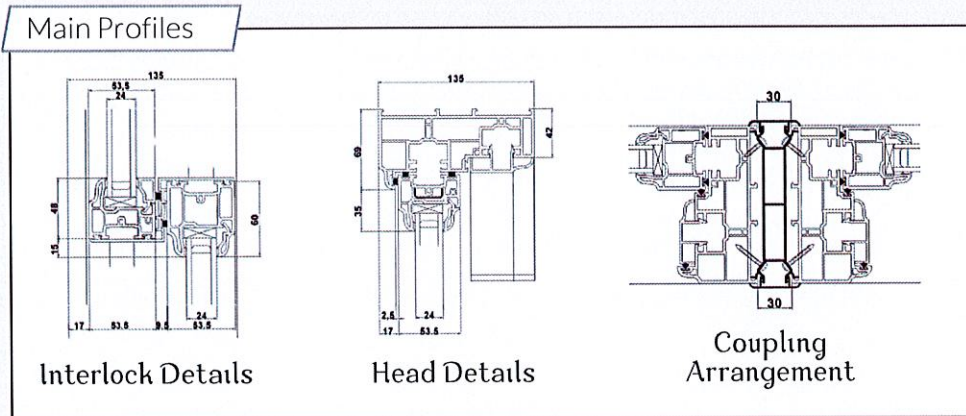

* Please note that some slide and tilt restrictions may apply on very large/small and bespoke shaped windows. For min/max sizes for seamless welded windows please refer to page 5.



The images, drawings and data shown in this brochure are for illustrative purposes only and are not binding in detail, colour or specification. We reserve the right to make changes to the product specification as technical developments dictate and without prior notice.

